

SAMS

CC16 08978

COMPUTERFACTS™

TECHNICAL SERVICE DATA

ATARI®
MODEL 130XE
COMPUTER

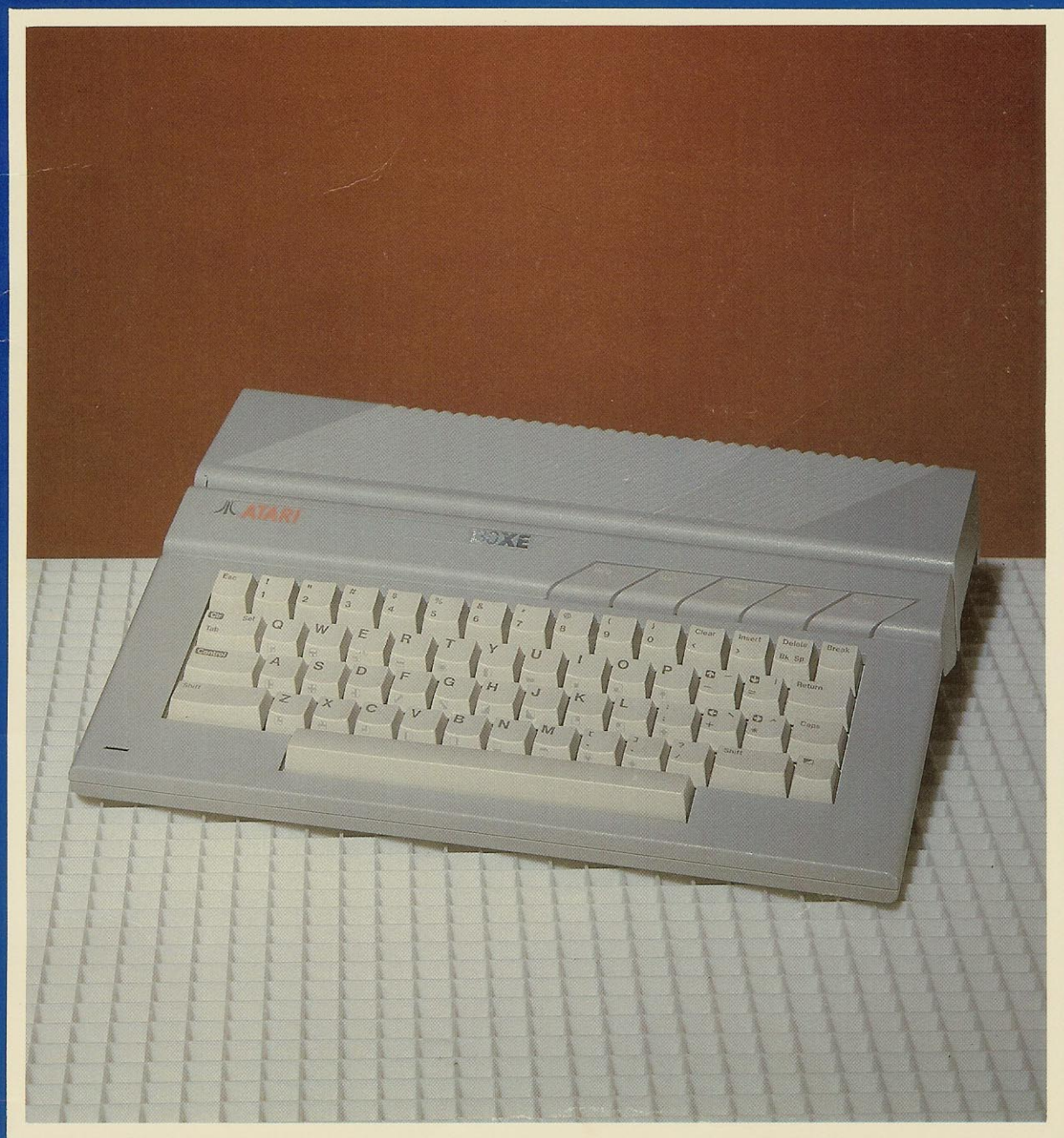

FEATURES: COMPLETE SCHEMATICS • PRELIMINARY SERVICE CHECKS • TROUBLESHOOTING TIPS •
EASY-READ WAVEFORMS • REPLACEMENT PARTS LISTS • SEMICONDUCTOR CROSS-REFERENCE

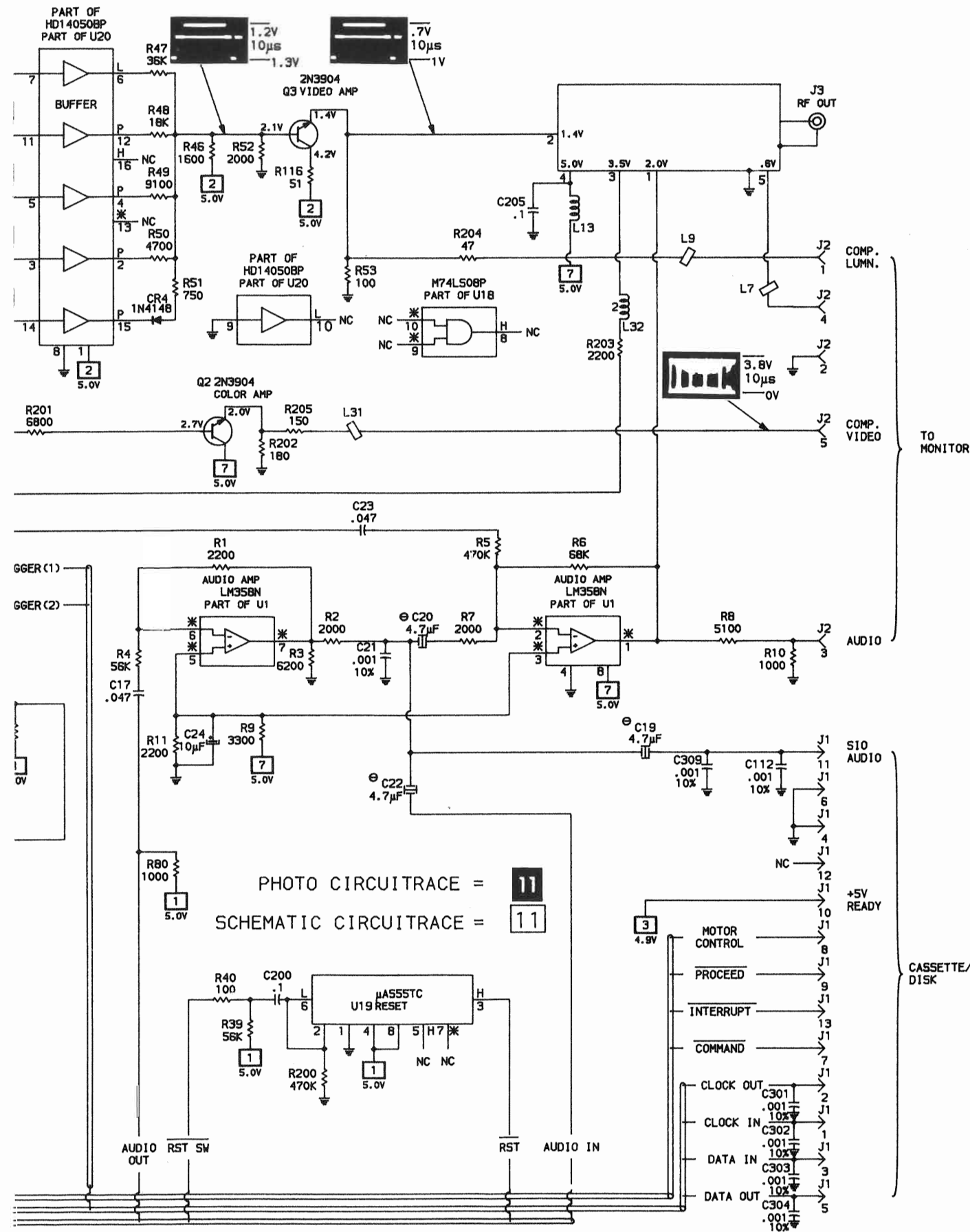

ATARI
MODEL 130XE



ATARI
MODEL 130XE
CC16

ATARI
MODEL 130XE
CC16

PRELIMINARY SERVICE CHECKS
ENCLOSED

SAFETY PRECAUTIONS
See page 19.

INDEX

	Page		Page
Block Diagram	20	Photos	
Disassembly Instructions	18	Main Board	5 thru 8, 21 thru 24
General Operating Instructions	18	Safety Precautions	19
IC Pinouts and Terminal Guides	4,25	Schematics	2,3,27,28,29
Line Definitions	26	Schematic Notes	26
Logic Charts	16,17	Test Equipment	9
Miscellaneous Adjustments	18	Troubleshooting	9 thru 12
Parts List	13,14,15		

SAMS™ Howard W. Sams & Co.

4300 West 62nd Street, P.O. Box 7092, Indianapolis, Indiana 46206 U.S.A.

The listing of any available replacement part herein does not constitute in any case a recommendation, warranty or guaranty by Howard W. Sams & Co. as to the quality and suitability of such replacement part. The numbers of these parts have been compiled from information furnished to Howard W. Sams & Co. by the manufacturers of the particular type of replacement part listed.

Reproduction or use, without express permission, of editorial or pictorial content, in any manner, is prohibited. No patent liability is assumed with respect to the use of the information contained herein.
© 1986 Howard W. Sams & Co.
4300 West 62nd Street, P.O. Box 7092, Indianapolis, Indiana 46206 U.S.A.
Printed in U.S. of America. 86CC14978 DATE 8-86

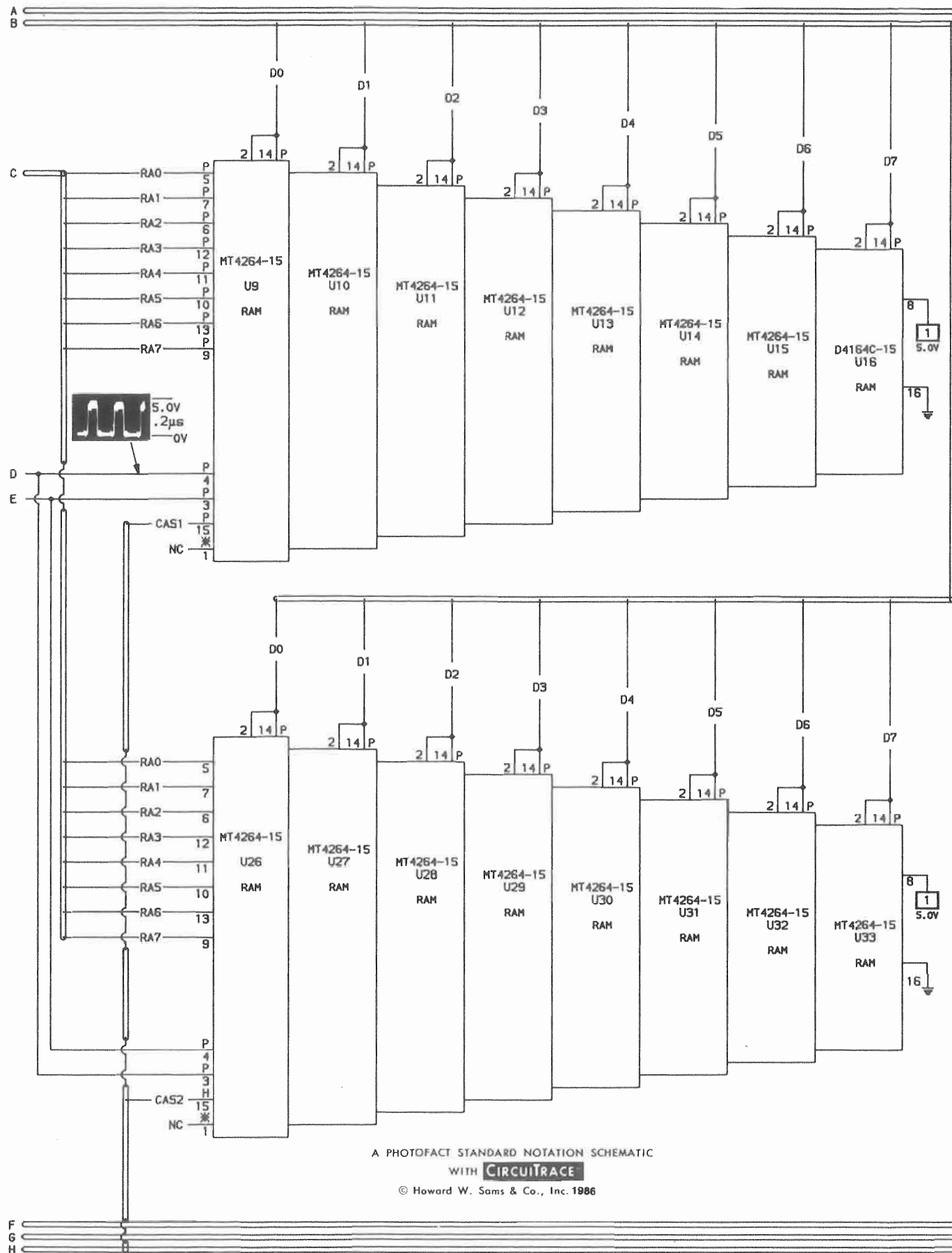

CABLING:
 HEAVY LINES REDUCE
 USE OF MULTIPLE LINES

SEE PINOUTS, TERMINAL
 GUIDES AND SCHEMATIC
 NOTES ON PAGES 4, 25, 26

SEE PINOUTS, TERMINAL
 GUIDES AND SCHEMATIC
 NOTES ON PAGES 4, 25, 26

4.6V
 10µs
 0V

4.8V
 .1µs
 0V

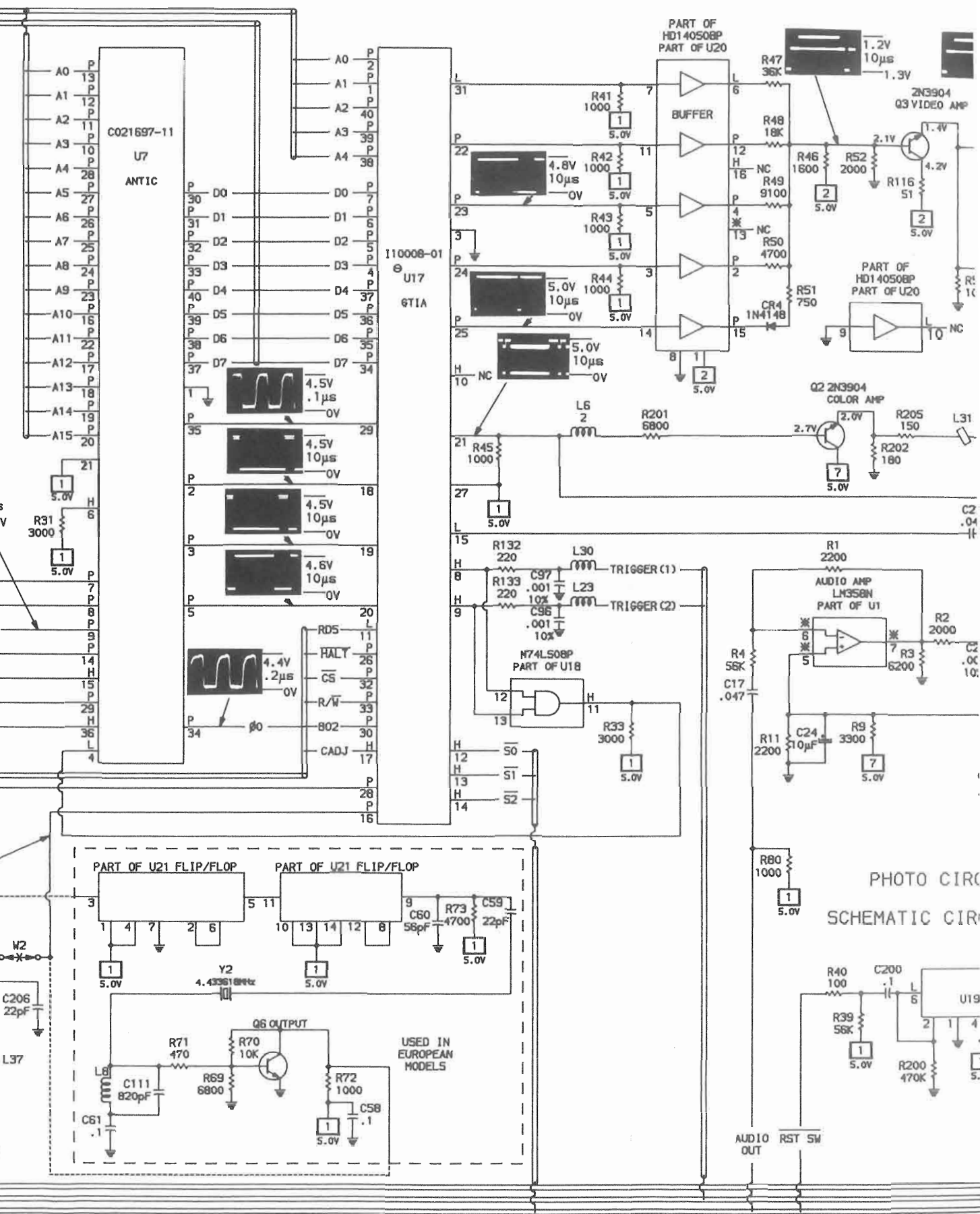

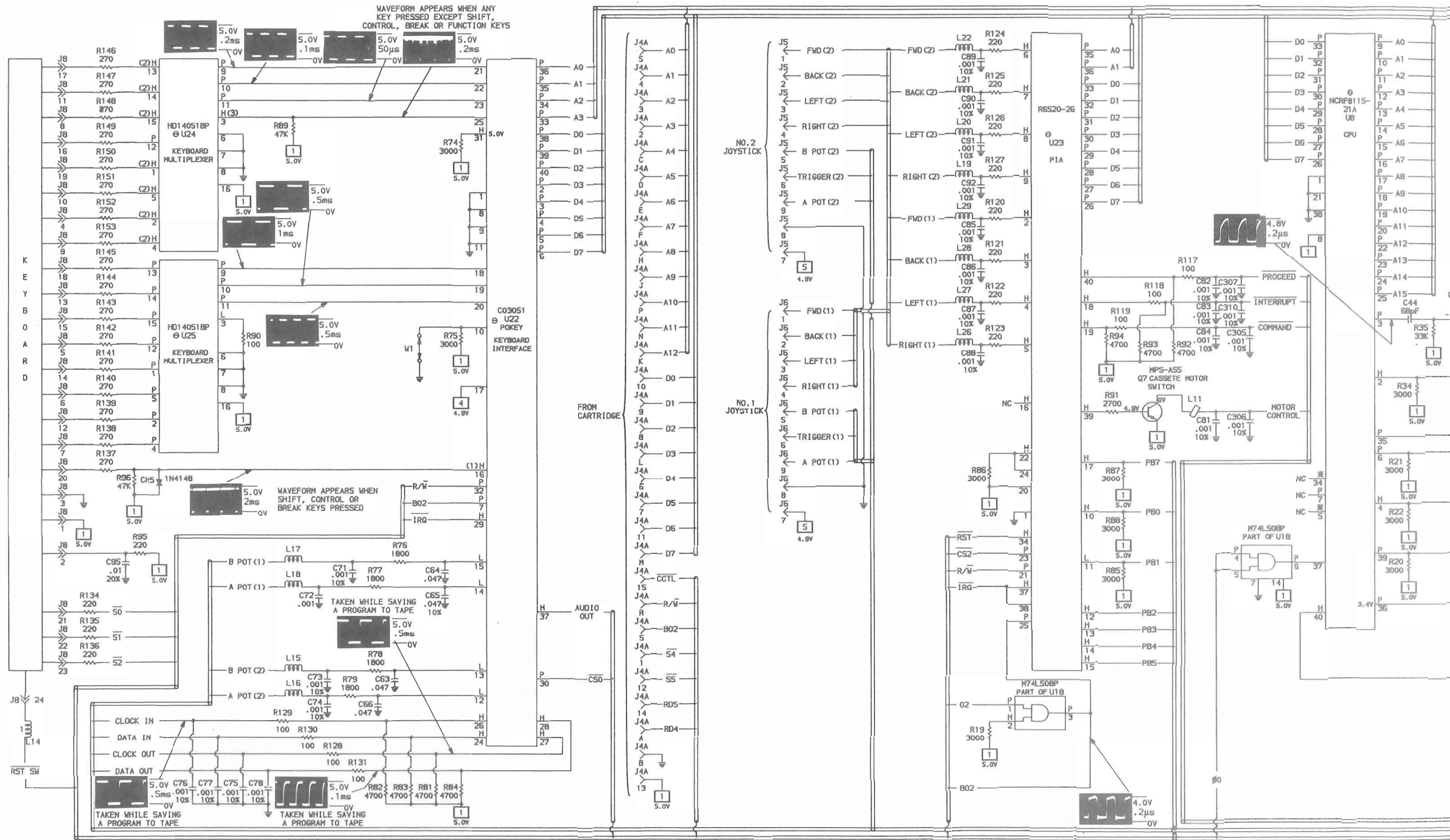

A PHOTOFAC STANDARD NOTATION SCHEMATIC

WITH **CIRCUITRACE**

© Howard W. Sams & Co., Inc. 1986

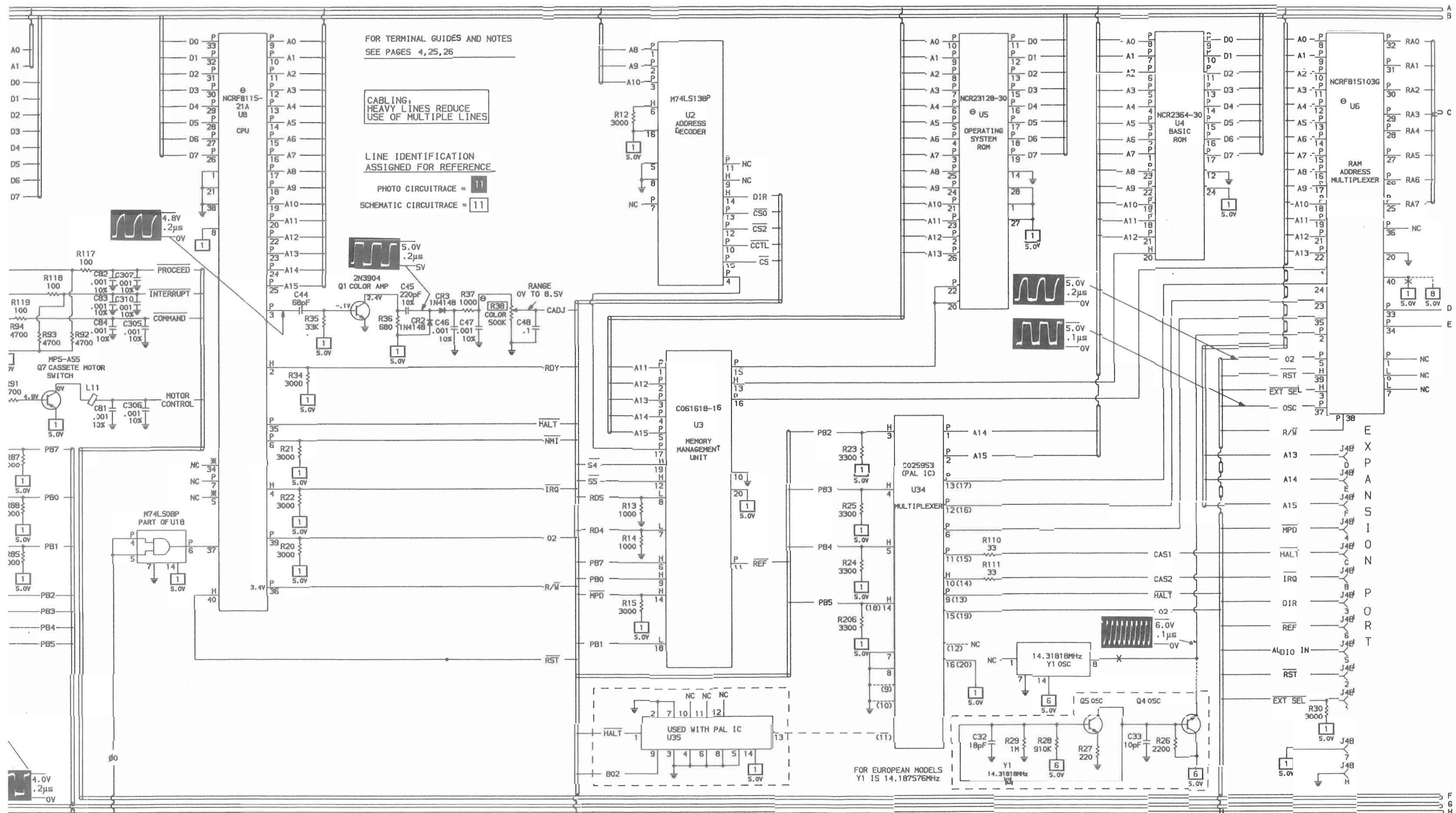

LINE DEFINITIONS

A POT(1), A POT(2) Joystick Controls (One) And (Two)
 A0 THRU A15 Address
 AUDIO Audio Signal
 AUDIO IN Audio Signal Input
 AUDIO OUT Audio Signal Output
 B POT(1), B POT(2) Joystick Controls (One) And (Two)
 B02 Phase Two Clock Output
 BACK(1), BACK(2) Joystick Control (One) And (Two)
 CADJ Color Delay
 CAS0, CAS1, CAS2 Column Address Strobe 0, 1, 2
 CCTL Cassette Control
 CLOCK IN Clock Input
 CLOCK OUT Clock Output
 COMMAND Command
 COMP. LUMN Composite Luminance
 COMP. VIDEO Composite Video
 CS, CS2 Chip Select
 D0 THRU D7 Data
 DATA IN Data Input
 DATA OUT Data Output
 DIR Direction
 EXT SEL External Select
 FWD(1), FWD(2) Joystick Control (One) And (Two)
 HALT Halt CPU Input
 INTERRUPT Interrupt

IRQ Interrupt Request
 LEFT(1), LEFT(2) Joystick Control (One) And (Two)
 MOTOR CONTROL Cassette Motor Control
 MPD Math-Pack Disable
 NMI Non-Maskable Interrupt
 O2 Clock, Phase Two
 OSC Oscillator
 PB0 THRU PB5, PB7 Port B, Bits 0 Thru 5, 7
 PROCEED Proceed
 R/W Read/Write
 RA0 THRU RA7
 RD4, RD5
 RDS
 RDY Ready
 REF Reference
 RIGHT(1), RIGHT(2) Joystick Controls (One) And (Two)
 RST Reset
 RST SW Reset Switch
 S0, S4, S5
 S1 Start
 S2 Select
 SIO AUDIO Serial Input Output Audio
 TRIGGER (1), TRIGGER (2) Joysticks Trigger
 Input (One) And (Two)
 O0 Phase Zero Clock

SCHEMATIC NOTES

- ✖ Circuitry not used in some versions
- Circuitry used in some versions
- ⊕ See parts list
- ⊕ Ground

Waveforms and voltages taken from ground, unless noted otherwise.

Voltages, Waveforms and Logic probe readings taken with Computer turned On, no keys pressed, unless otherwise noted.

Waveforms taken with triggered scope and Sweep/Time switch in Calibrate position, scope input set for DC coupling on 0 reference voltage waveforms. Switch to AC input to view waveforms after DC reference is measured when necessary. Each waveform is 7 cm. width with DC reference voltage given at the bottom line of each waveform.

Time in μ sec. per cm, given with p-p reading at the end of each waveform.

Item numbers in rectangles appear in the alignment/adjustment instructions.

Supply voltages maintained as shown at input.

Voltages measured with digital meter, no signal.

Controls adjusted for normal operation.

Terminal identification may not be found on unit.

Capacitors are 50 volts or less, 5% unless noted.

Electrolytic capacitors are 50 volts or less, 20% unless noted.

Resistors are $\frac{1}{2}$ W or less, 5% unless noted.

Value in () used in some versions.

Measurements with switching as shown, unless noted.

Logic Probe Display

L = Low

H = High

P = Pulse

* = Open (No light On)

(1) Probe indicates P when SHIFT, CONTROL or BREAK key is pressed.

(2) Probe indicates P when certain keys are pressed.

(3) Probe indicates P when any key is pressed except SHIFT, CONTROL, BREAK, START, SELECT, OPTION or RESET.

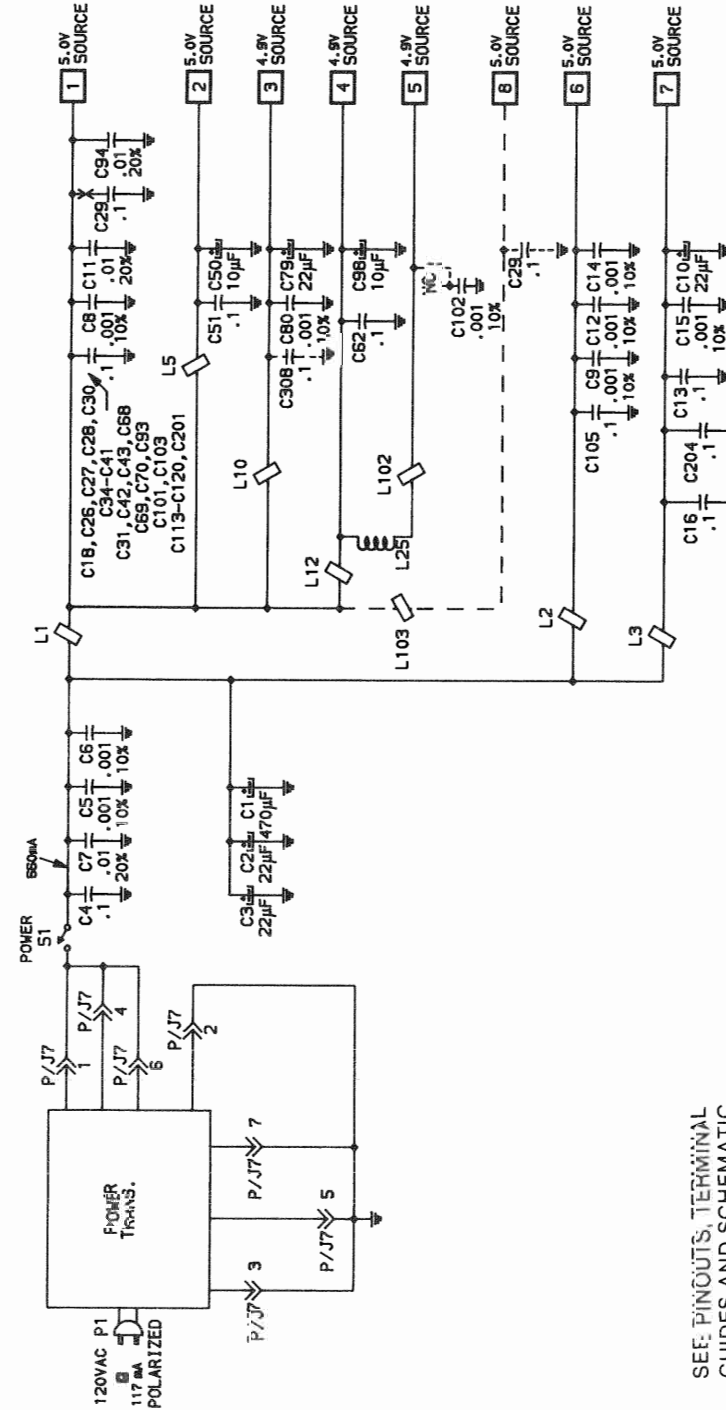

SEE PINOUTS, TERMINAL GUIDES AND SCHEMATIC NOTES ON PAGES 4, 25, 26

PHOTO CIRCUITTRACE = 11
 SCHEMATIC CIRCUITTRACE = 11

CC16
 ATARI
 MODEL 130XE

IC PINOUTS & TERMINAL GUIDES

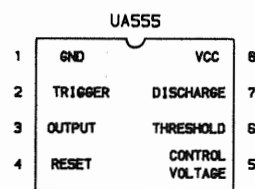
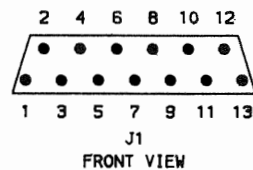

U19
TIMER
TOP VIEW

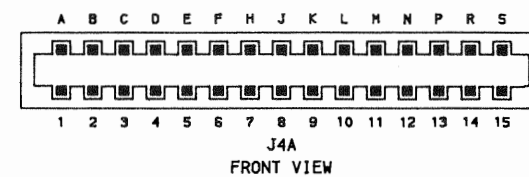
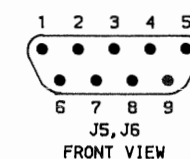
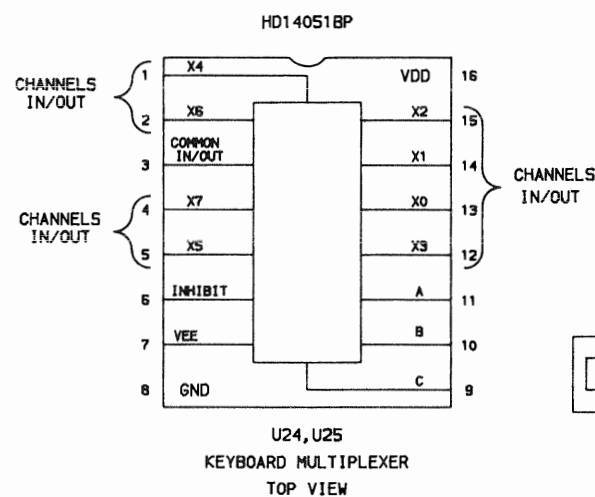
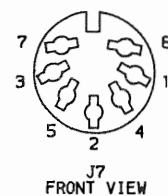
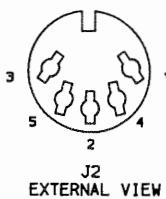
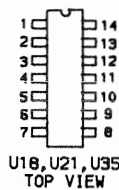
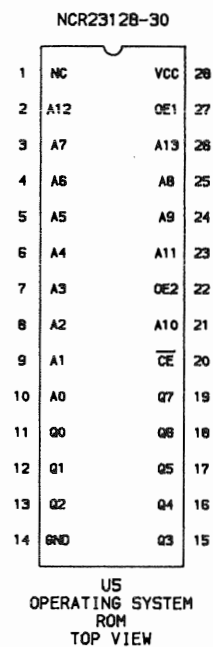
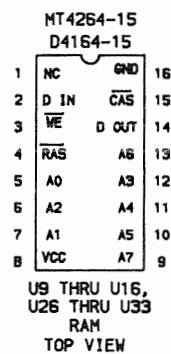
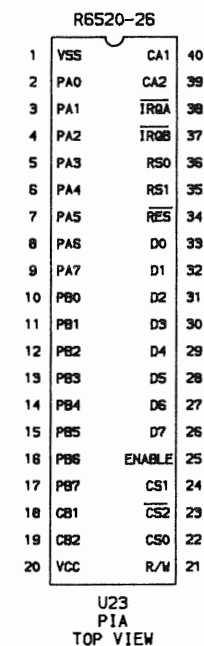
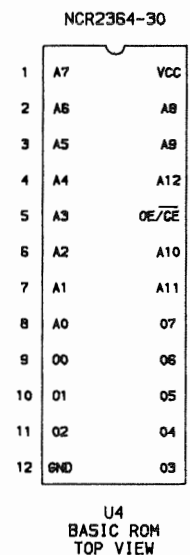
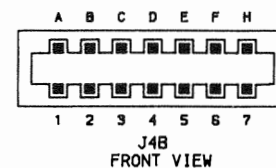
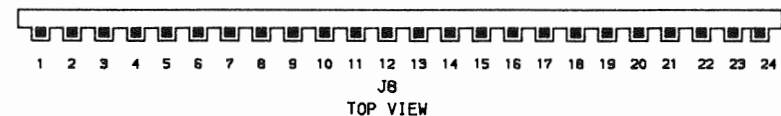
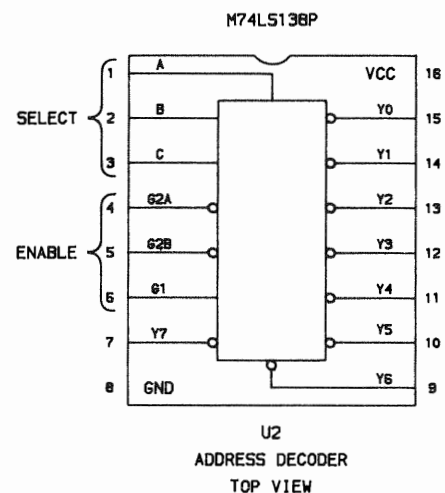
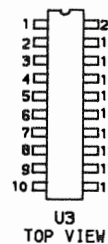
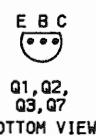
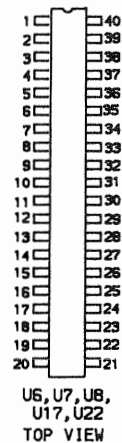

ATARI
MODEL 130XE

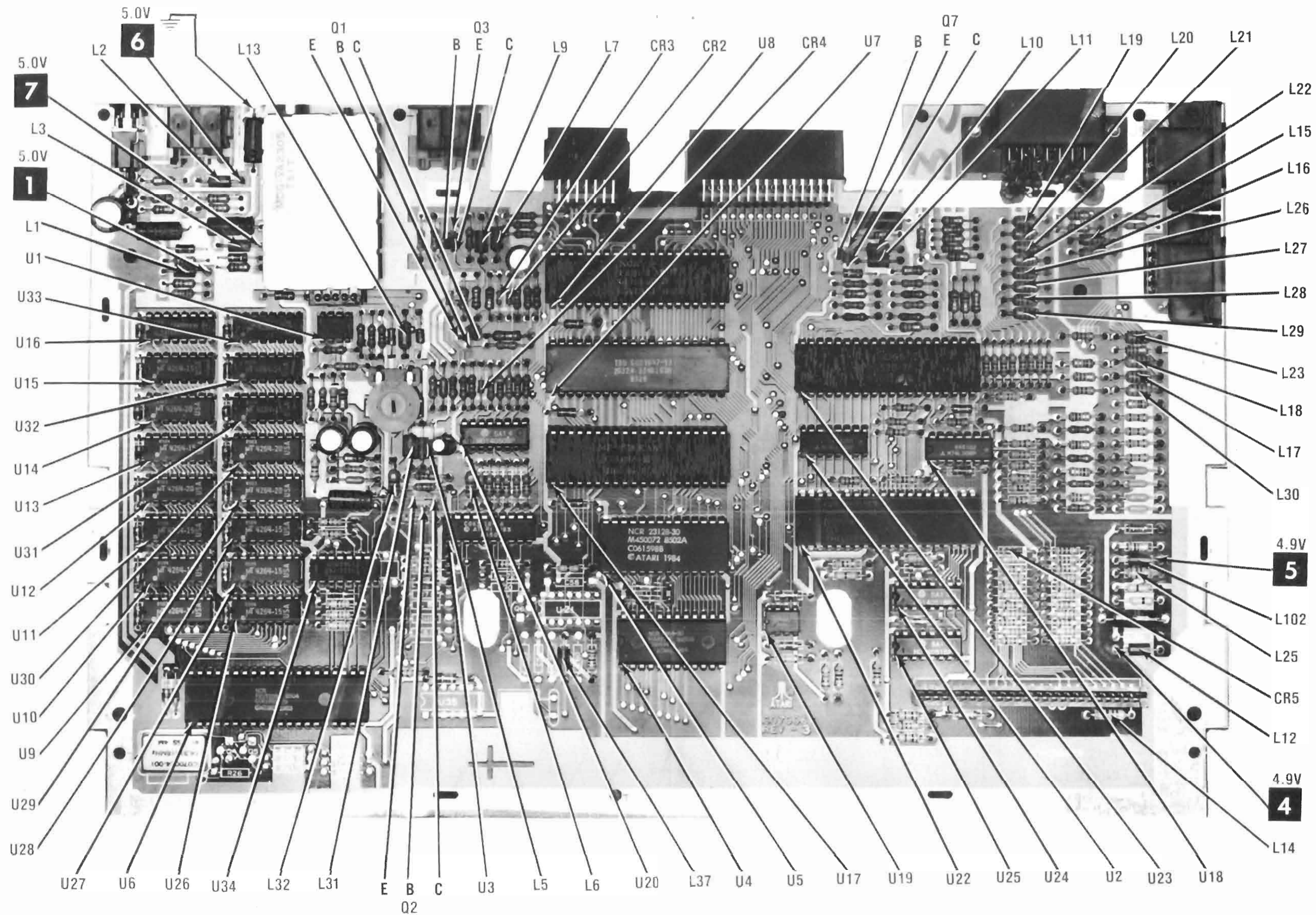

CC-16
 ATARI
 MODEL 130XE

ARROWS ON IC'S INDICATE PIN 1 UNLESS NOTED

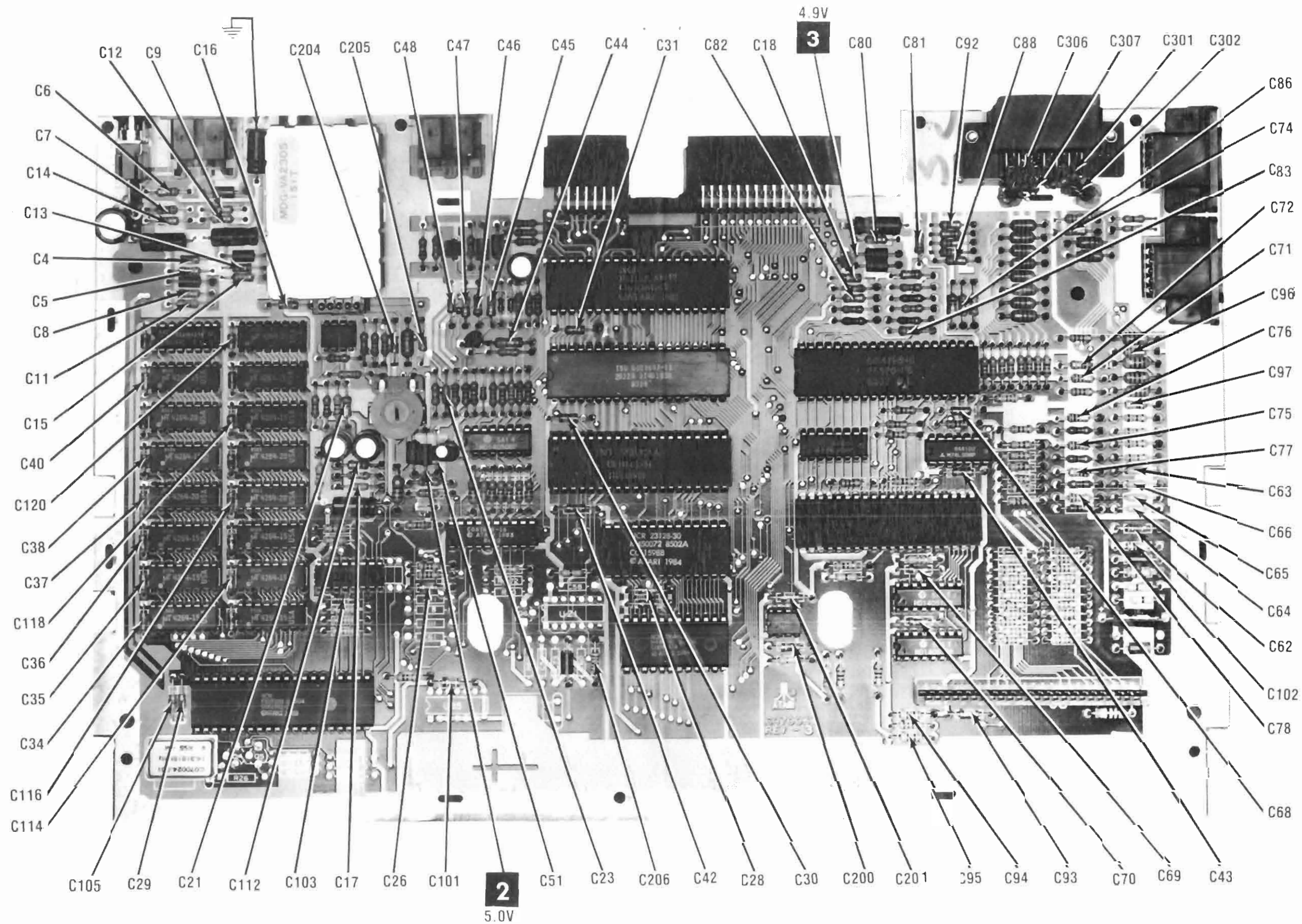

ATARI
MODEL 130XE

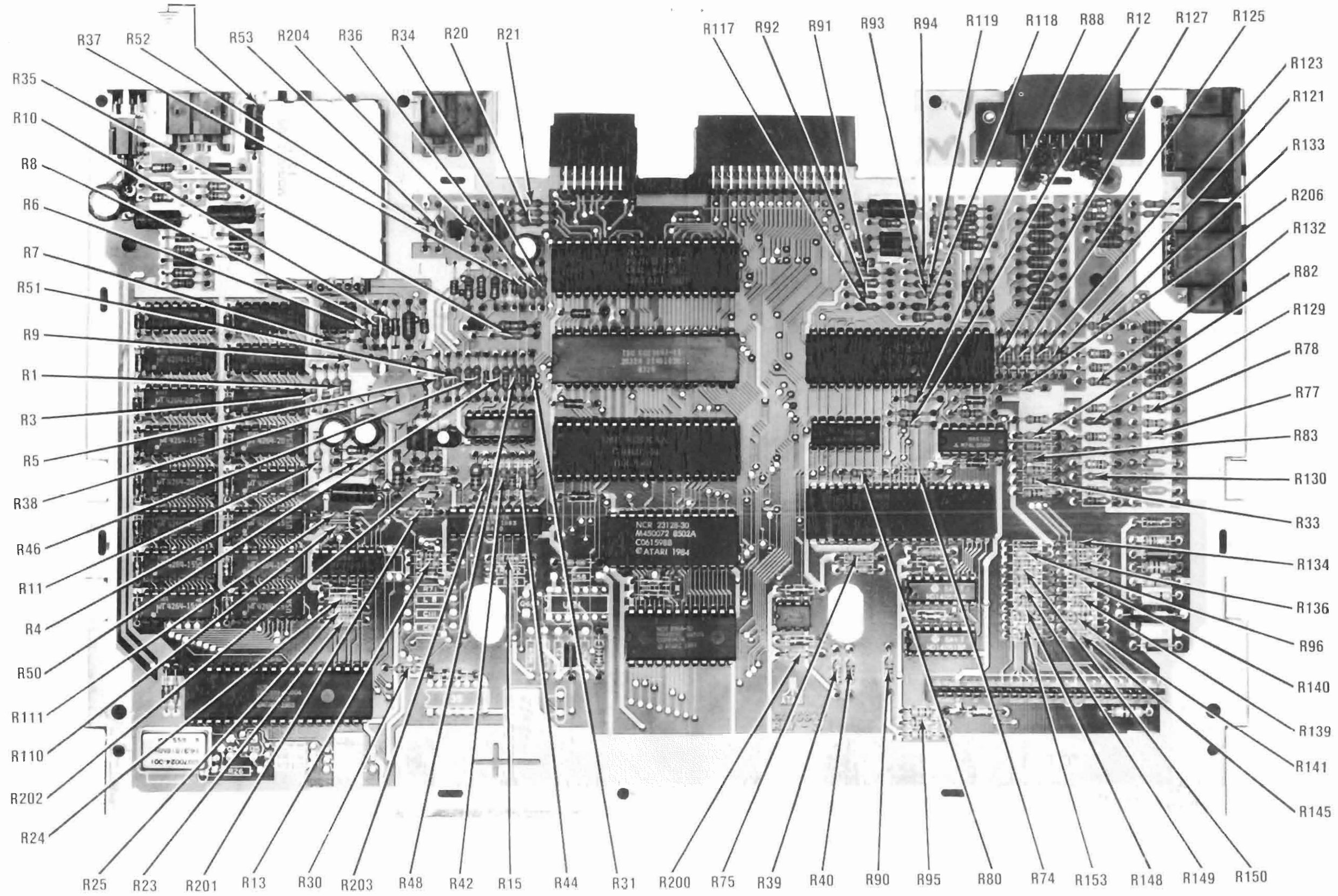

CC16
ATARI
MODEL 130XE

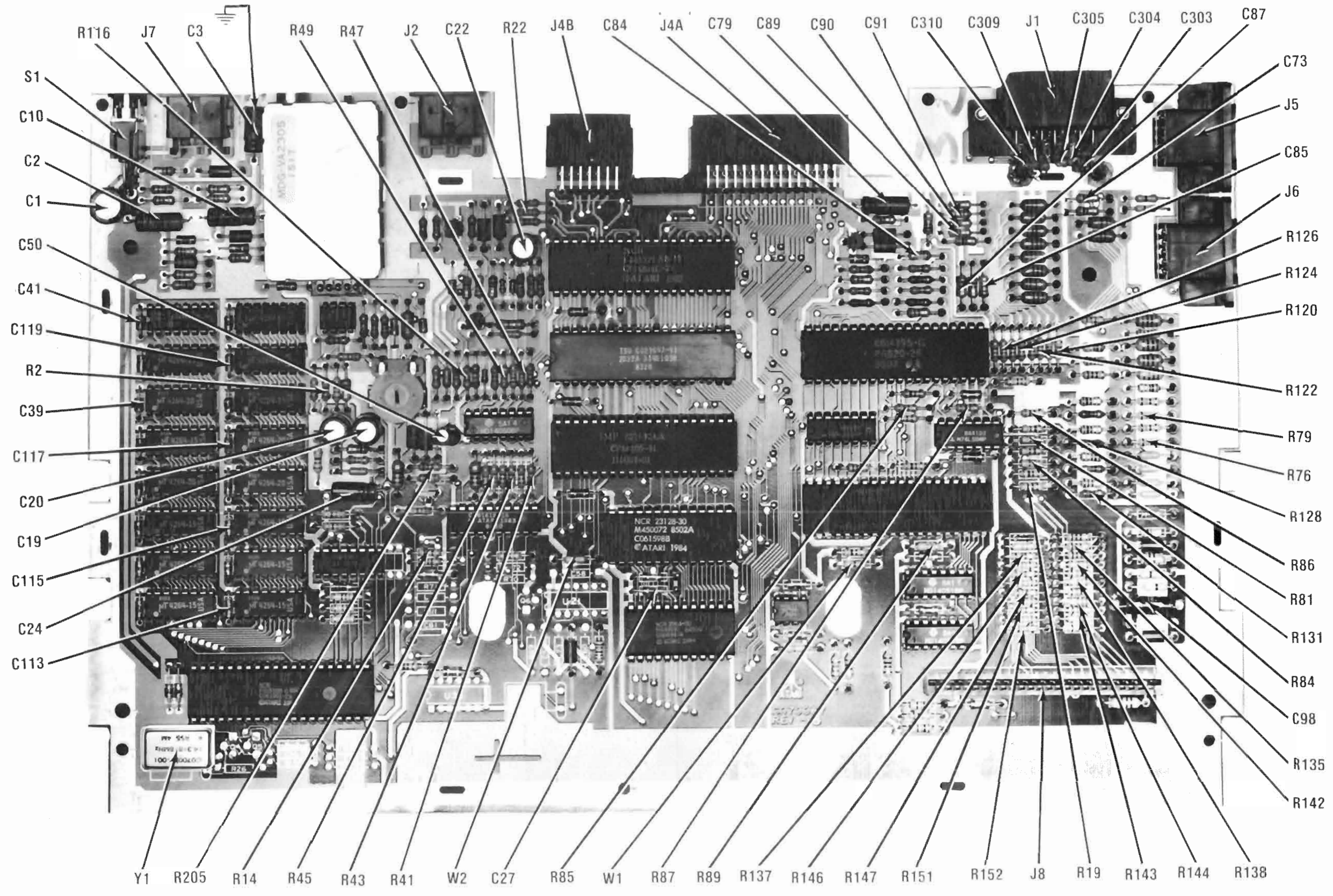

ATARI
MODEL 130XE

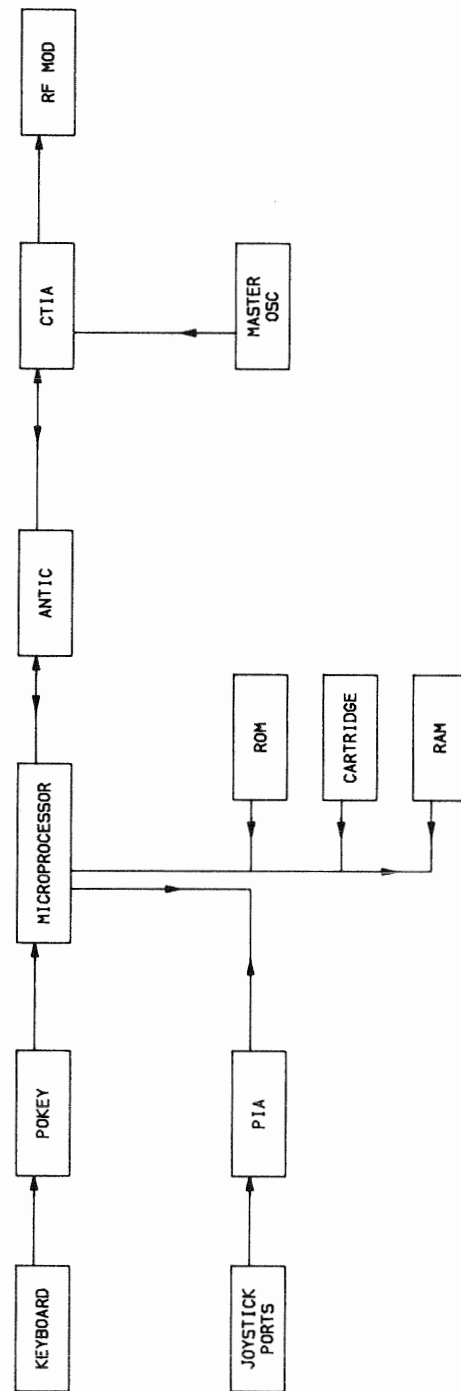

BLOCK DIAGRAM

TEST EQUIPMENT

Test Equipment listed by Manufacturer illustrates typical or equivalent equipment used by SAMS' Engineers to obtain measurements and is compatible with most types used by field service technicians.

TEST EQUIPMENT (COMPUTERFACTS)

Equipment Name	B & K Precision Equipment No.	Sencore Equipment No.
OSCILLOSCOPE	1570A, 1590A, 1596	SC61
LOGIC PROBE	DP51	
LOGIC PULSER	DP101	
DIGITAL VOM	2830	DVM37, DVM56, SC61
ANALOG VOM	277	
ISOLATION TRANSFORMER	TR110, 1604, 1653, 1655	PR57
FREQUENCY COUNTER	1803, 1805	FC71, SC61
COLOR BAR GENERATOR	1211A, 1248, 1251, 1260	CG25, VA62
RGB GENERATOR	1260	
FUNCTION GENERATOR	3020	
HI-VOLTAGE PROBE VOM/DMM Accessory probes	HV-44	HP200
TEMPERATURE PROBE	TP-28	
CRT ANALYZER	467, 470	CR70

TROUBLESHOOTING

SELF-TEST

The Computer has a built-in self-test. To display the self-test menu, hold the Option key down while turning the Computer On or type the word BYE and press the Return key if the Computer is already On and in Basic. Press the Select key to select the desired test, the Start key to start the test and the Help key to go back to the self-test menu or the Reset key to go back to Basic. The self-test will check the ROM and RAM memory, audio, video and keyboard circuits.

When the Memory test is run, two bars will appear which represent the Operating System ROM IC (U5), then 48 squares will appear, each square representing 1K of RAM IC's (U9 thru U16). While the ROM or RAM is being tested, the color of the bar or square will be white, then change to green if the ROM or RAM is good or red if the ROM or RAM is bad. If BYE is used to enter the self-test menu only 40 squares will appear during the RAM test.

When the Audio-Visual test is run, a music staff and treble clef will appear on the screen. A tune of six tones is produced with the corresponding note appearing on the screen when that note is played. Sound channels 1 thru 4 Pokey IC (U22) are tested. An audio defect is indicated by a note appearing on the screen with no sound. A video defect ANTIC IC (U7) and GTIA IC (U17) is indicated by a tone sounding with no note appearing on the screen.

When the Keyboard test is run, the keyboard layout is displayed on the screen. When a key is pressed the corresponding key on the screen should change to inverse video and a tone should sound. The Control and Shift keys will work only when pressed along with another key. All keys except the Reset, Help and Break keys are tested. IC's U17 and U22 are tested.

POWER SUPPLY

Unplug the Power Pack and check for 5.0V from pin 3 to pin 1 of Plug P7. If 5.0V is missing check Plug P7 and the cable for possible open circuits. If the Plug P7 and cable check good replace the Power Pack. Before plugging the new Power Pack into the Computer, check for a possible short from pin 3 to pin 1 of Jack J7 with the Power Switch (S1) in the On position.

If there are no shorts, plug Power Pack into Computer, turn Computer On and check for 5.0V on the positive end of Electrolytic C2. If 5.0V is missing, check the Power Switch (S1).

MICROPROCESSOR (CPU) OPERATION

Check the operation of the Reset Circuit at pin 3 of Reset IC (U19). Pin 3 should read a logic Low momentarily, then go logic High and stay High when the Computer is turned On or the Reset key is pressed. If the Reset reading is not correct check Capacitor C200, Resistors R39 and R40 and IC U19.

Verify the operation of the Clock Circuits by checking for a 1.78977MHz clock waveform at pin 25 of PIA IC (U23). If the waveform is missing or off frequency refer to the "Clock and DIVIDERS" section of this Troubleshooting guide.

Check for pulses on the Address pins (pins 9 thru 20 and 22 thru 25) and Data pins (pins 26 thru 33) of the CPU IC (U8). If pulses are missing or one pin appears to be stuck at a logic Low or High, turn the Computer Off, remove IC U8, turn the Computer back On and recheck the Address and Data pins. The Address pins should read a logic Open and the Data pins a logic High. If pulses are missing with IC U8 in the Computer, check for pulses on the Data pins (pins 26 thru 33) of IC U8 while turning the Computer On or pressing the Reset key. If pulses appear, then suddenly stop, check the Address Decoder IC (U2), Memory Management Unit IC (U3), Operating System and Basic ROM IC's (U4 and U5) and CPU IC (U8).

CC-16
ATARI
MODEL 130XE

TROUBLESHOOTING (Continued)

CLOCK AND DIVIDERS

Check for 14.31818MHz at pin 2 of RAM Address Multiplexer IC (U6). If waveform is missing or off frequency check Oscillator (Y1). If waveform is good check for 3.579545MHz at pin 37 of IC U6. If waveform is missing check IC U6. Check for 1.78977MHz at pin 5 of IC U6. If waveform is missing check IC U6. If waveform is good check for 1.78977MHz at pin 30 of GTIA IC (U17). If waveform is missing check IC U17.

VIDEO

If there is no video on the Monitor screen and the RF Modulator output is being used, check for a video waveform at pin 2 of the RF Modulator. If the waveform is present, check the RF Modulator, Channel Select Switch (S2) and cable going to the Monitor. If the waveform is missing at pin 2 of the RF Modulator, check for a video waveform at the emitter of the Video Amp Transistor (Q3). If the waveform is missing at the emitter of Transistor Q3, check the waveform at the base of Transistor Q3. If the waveform is present at the base of Transistor Q3, check Transistor Q3 and the components associated with Transistor Q3. If the waveform is missing at the base of Transistor Q3, check the waveform at pin 5 of the Buffer IC (U20). If the waveform is present at pin 5 of IC U20, check Resistor R49 and IC U20. If the waveform is missing at pin 5 of IC U20, check the GITA IC (U17) and ANTIC IC (U7).

COLOR

If the color is not correct, check the adjustment of the Color Control (R38), see "Miscellaneous Adjustments". If adjusting R38 has no affect, check for a voltage range of 0V to 8.5V at pin 17 of the GTIA IC (U17) while turning R38 from minimum to maximum. If the voltage is missing or does not vary, check Control R38 and the voltages, waveforms and components associated with Color Amp Transistor (Q1). If the voltage range is correct at pin 17 of IC U17, check for a frequency of 3.579545MHz at pin 28 of IC U17. If the frequency is not correct refer to the "Clock and Divider" section of this Troubleshooting guide. If the frequency is correct, check IC U17.

If there is no color, check the waveform at pin 21 of IC U17. If the waveform is missing, check IC U17. If the waveform is present at pin 21 of IC U17, check the waveform at pin 3 of RF Modulator. If the waveform is missing, check Resistor R203 and Coil L32.

VERTICAL AND HORIZONTAL SYNC

If there is no vertical or horizontal sync, check the waveform at pin 25 of GTIA IC (U17). If the waveform is missing check IC U17. If the waveform is present, check Buffer IC (U20), Diode CR4 and Resistor R51.

SOUND

No sound. Type in and run the following program in Basic.

```
10 SOUND 0, 100, 10, 15: GOTO 10
```

Check for pulses at pin 37 of the POKEY IC (U22). If pulses are missing check IC U22. If pulses are present at pin 37, check the waveform at pin 1 of the Audio Amp IC (U1), see Figure 1. If the waveform is missing check the voltages and components associated with pins 1 thru 8 of IC U1. If the waveform is present at pin 1 of IC U1, check the RF Modulator.

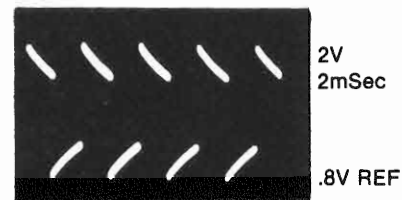

Figure 1

If there is sound when running the above program, but there is no clicking sound when a key is pressed, check for pulses at pin 15 of the GTIA IC (U17) while pressing a key. If pulses are missing check IC U17. If pulses are present check Capacitor C23 and Resistor R5.

Sound works when RF modulator is used, but not when using a Video/Audio Monitor connected to Jack J2. Check the connections at Jack J2 and check Resistors R8 and R10.

Sound works when above program is run, but not when the audio input of Jack J4B pin 5 is used. Check Electrolytic C22.

Sound works when above program is run, but not when the audio input of Jack J1 pin 11 is used. Check Electrolytic C19.

KEYBOARD

If the keyboard is dead, check Connector J8 for good connections and check the ribbon cable for defects. If the connector and cable check good, check the waveforms at pins 18 thru 23 of the POKEY IC (U22). If the waveforms are missing, check IC U22. If the waveforms are present at pins 18 thru 23 of IC U22, check the waveform at pin 3 of the Keyboard Multiplexer IC (U24) while pressing any key except the Shift, Control, Break or Function keys. If the waveform is missing at pin 3 of IC U24, check IC's U24 and U25. If the waveform is present at pin 3 of IC U24 check the GTIA IC (U17) and IC U22.

If the Start, Select or Option keys do not work, check the logic readings at pins 12, 13 and 14 of IC U17. Pin 12 should read logic Low when the Start key is pressed, pin 13 should read logic Low when the Select key is pressed and pin 14 should read logic Low when the Option key is pressed. If the logic readings are correct check IC U17. If the logic readings are not correct check the keyboard Connector J8, ribbon cable and Resistors R134, R135 and R136.

If the Shift, Control or Break keys do not work, check the waveform at pin 16 of IC U22 while pressing the Shift, Control or Break keys. If the waveform is present, check IC U22.

SAFETY PRECAUTIONS

1. Use an isolation transformer for servicing.
2. Maintain AC line voltage at rated input.
3. Remove AC power from the computer before servicing or installing electrostatically sensitive devices. Examples of typical ES devices are integrated circuits and semiconductor "chip" components.
4. Use extreme caution when handling the printed circuit boards. Some semiconductor devices can be damaged easily by static electricity. Drain off any electrostatic charge on your body by touching a known earth ground. Wear a commercially available discharging wrist strap device. This should be removed prior to applying power to the unit under test.
5. Use a grounded-tip, low voltage soldering iron.
6. Use an isolation (times 10) probe on scope.
7. Do not remove or install boards, floppy disk drives, printers, or other peripherals with computer AC power On.
8. Do not use freon-propelled sprays. These can generate electrical charges sufficient to damage semiconductor devices.
9. This computer is equipped with a grounded three-pronged AC plug. This plug must fit into a grounded AC power outlet. Do not defeat the AC plug safety feature.
10. Periodically examine the AC power cord for damaged or cracked insulation.
11. The computer cabinet is equipped with vents to prevent heat build-up. Never block, cover, or obstruct these vents.
12. Instructions should be given, especially to children, that objects should not be dropped or pushed into the vents of the cabinet. This could cause shock or equipment damage.
13. Never expose the computer to water. If exposed to water, turn the unit off. Do not place the computer near possible water sources.
14. Never leave the computer unattended or plugged into the AC outlet for long periods of time. Remove AC plug from AC outlet during lightning storms.
15. Do not allow anything to rest on AC power cord.
16. Unplug AC power cord from outlet before cleaning computer.
17. Never use liquids or aerosols directly on the computer. Spray on cloth and then apply to the computer cabinet. Make sure the computer is disconnected from the AC power line.

DISASSEMBLY INSTRUCTIONS

CABINET REMOVAL

Remove four screws from cabinet bottom. Lift cabinet top up and disconnect keyboard cable. Cabinet top may now be removed.

MAIN BOARD REMOVAL

Remove seven screws holding PC board to cabinet bottom. Lift PC board and metal shield from cabinet bottom. To remove shield, twist seven tabs holding shield together and remove shield from main board.

GENERAL OPERATING INSTRUCTIONS

POWER UP

Computer will come up ready to program in Basic when turned On.

For instructions on loading and saving programs with an Atari Recorder see the "Cassette Operation" section.

To run a program type RUN and press the RETURN key. To stop a program, press the BREAK key.

To load a program, type CLOAD and press the RETURN key. The speaker will beep once. After the speaker beeps, push the PLAY button on the Recorder and press the RETURN key again. The program will then load. The word READY on the screen indicates the loading is completed. The Recorder will shut-off automatically.

To save a program, type CSAVE and press the RETURN key. The speaker will beep twice. After the speaker beeps, press the PLAY and RECORD buttons on the Recorder and then press the RETURN key. The program will then save. The word READY on the screen indicates the program has been saved. The Recorder will shut-off automatically.

CASSETTE OPERATION

Connect the Atari Program Recorder to the connector on the right side of the Computer. NOTE: A standard tape recorder will not work with this Computer.

MISCELLANEOUS ADJUSTMENTS

COLOR

Turn the Computer On and adjust the Color Control (R38) for a blue screen on the Monitor.

TROUBLESHOOTING (Continued)

If the waveform is missing at pin 16 of IC U22, check for the same waveform at pin 5 of Keyboard Multiplexer IC (U25) while pressing the Shift key, at pin 4 of U25 while pressing the Control key and at pin 14 of U25 while pressing the Break key. If the waveform is missing at pin 4, 5 or 14 of U25, check IC U25. If the waveform is present at pins 4, 5, and 14 of U25, check Resistors R96 and R137. Also check keyboard Connector J8 for good connections.

If there is no clicking sound when a key is pressed, check for pulses at pin 15 of IC U17 while pressing a key. If pulses are missing, check IC U17. If pulses are present, check Capacitor C23 and Resistor R5.

If one key is erratic, clean the key.

If characters come up wrong on the Monitor screen when a key is pressed, check IC's U7, U17 and U22.

If one key or group of keys do not work, use the following chart to determine which pins of Connector J9 connect to the defective keys. Check the keys for continuity, each key should measure about 55 ohms. If the keys check good, turn the Computer On and use a scope to check for pulses at Connector J9 while pressing the defective keys. Note: A logic probe may indicate pulses even when no key is pressed.

J8 PIN	(Connect to IC U24) KEYS
19	6, 7, Y, U, N
4	H, J, SPACE
9	4, 9, R, O, F, L, V, ,
10	3, 0, E, P, D, ;, C, .
16	ESC, BACKS, TAB, RETURN, CAPS
17	1, >, Q, =, A, *, Z, □
11	2, <, W, -, S, +, X, /
8	5, 8, T, I, G, K, B, M
J8 PIN	(Connect to IC U25) KEYS
14	ESC, 1, 2, 3, 4, 5, 6
12	U, I, O, P, -, =, RETURN
7	J, K, L, ;, +, *, CTRL
6	SHIFT, Z, X, C, V, B
5	N, M, ,, , /, , , SPACE
18	A, S, D, F, G, H
13	BREAK, 7, 8, 9, 0, <, >, BREAK
15	TAB, Q, W, E, R, T, Y

If pulses are missing check the Resistors that connect Connector J8 to IC's U24 and U25 and check IC's U24 and U25.

CASSETTE SAVE AND LOAD

Computer will not save a program on tape. Type a program or load an existing program into the Computer. Save the program back on tape, see "Cassette Operation" section of the General Operating Instructions. While saving the program, check the waveforms on pins 26, 27 and 28 of the POKEY IC (U22). If any of the waveforms are missing, check IC U22 by substitution. If the waveforms are correct, check the connections at pins 1, 2, and 5 of Jack J1.

Computer will not load a program from tape. Check for pulses at pin 24 of IC U22 while loading a program from tape, see "Cassette Operation" section of the General Operating Instructions. If the pulses are present, check the connections at pin 3 of Jack J1.

Recorder motor will not start when saving or loading a program. Type POKE 54018,52 and press the RETURN key. Check the logic probe reading on pin 39 of the PIA IC (U23). The reading should go from High to Low to start the recorder motor. If the reading stays High, check IC U23 by substitution. If the reading operates normally, check Switch Transistor (Q7) and check the connections at pin 8 of Jack J1. To turn the recorder motor Off, type POKE 54018,60 and press RETURN key.

PADDLES

The following Basic program can be used to check the operation of the paddles.

```
10 PRINT "PADDLE", "BUTTON"
20 FOR P=0 TO 3
30 PRINT "PADDLE"; P, PADDLE (P), PTRIG (P)
40 NEXT P
50 FOR T=1 TO 200: NEXT T
60 PRINT: GOTO 10
```

On the Monitor screen the number under PADDLE should vary from 228 to 1 as the paddle is varied from MINIMUM to Maximum. The number 1 under BUTTON should change to 0 when the button is pressed.

If a paddle does not function, use the following chart to determine which pin of the POKEY IC (U22) the paddle is connected to and check the waveform on the pin.

PORT	PADDLE	U22 PIN	BUTTON	U23 PIN
1	0	14	0	4
1	1	15	1	5
2	2	12	2	8
2	3	13	3	9

The waveform should vary from the sawtooth waveform shown in Figure 2 to the pulse waveform shown in Figure 3. If the waveform is missing, check the port connector, the paddle control and check IC U22 by substitution. If a button is not functioning, use the chart to determine which pin the button is connected to and use a logic probe to check the pin while the button is pressed. The logic probe reading should go from High to Low when the button is pressed. If the reading does not go Low, check the button switch and the port connector. If the logic reading is correct, check the PIA IC (U23) by substitution.

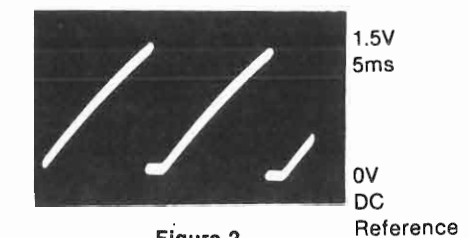

Figure 2

TROUBLESHOOTING (Continued)

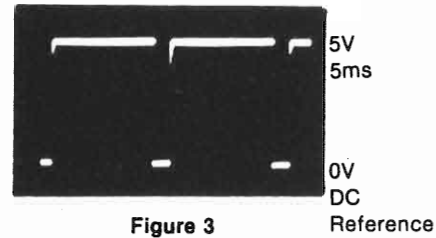

Figure 3

EXTRA RAM

The Computer contains 64K of extra memory RAM ICs (U26 thru U33) which can be accessed by "bank switching the CPU IC (U8) and ANTIC IC (U7). The bank switch is at Memory location 54017. The extra memory is switched in 16K sections and is addressed as the second block of memory (16384 to 32767).

The equation for selecting a bank of memory is:

$$193 + (4 \times \text{ADDRESS}) + (16 \times \text{MODE})$$

ADDRESS	MODE
0 0 TO 16383	0 EXTRA MEMORY
1 16384 TO 32767	1 NORMAL MEMORY
2 32768 TO 49151	2 EXTRA MEMORY
3 49152 TO 65535	3 NORMAL MEMORY

The normal value in memory location 54017 is 253.
 225 selects the first bank of extra memory.
 229 selects the second bank of extra memory.
 233 selects the third bank of extra memory.
 237 selects the fourth bank of extra memory.

The following Basic program can be used to check the entire 64K of extra memory. The program takes approximately 34 minutes to run.

```

10 PRINT "TESTING RAM"
20 POKE 54017, 225
30 GOSUB 120
40 POKE 54017, 229
50 GOSUB 120
60 POKE 54017, 233
70 GOSUB 120
80 POKE 54017, 237
90 GOSUB 120
100 PRINT "RAM CHECKS GOOD"
110 END
120 FOR X = 16384 TO 32767
130 POKE X,0
140 IF PEEK(X) = 0 THEN 160
150 GOTO 210
160 POKE X,255
170 IF PEEK(X) = 255 THEN 190
180 GOTO 210
190 NEXT X
200 RETURN
210 PRINT "RAM BAD AT LOCATION"; X
    
```

JOYSTICK PORT

The following Basic program can be used to check the operation of the joystick ports. Plug a joystick into the port being tested, type in and run the program.

```

10 PRINT "JOYSTICK", "BUTTON"
20 FOR P=0 TO 1
30 PRINT "PORT"; P + 1, STICK (P), STRIG (P)
40 NEXT P
50 FOR T = 1 TO 200: NEXT T
60 GOTO 10
    
```

On the Monitor screen the number 1 under BUTTON should change to 0 when the button is pressed. The number 15 under JOYSTICK should change to the following for each position of the joystick:

UP 14 LEFT 11
 DOWN 13 RIGHT 7

If the joystick is not working properly, check the logic readings on the PIA IC (U23) and GTIA IC (U17) pins that are used for the Joysticks. Use the following chart to determine which pin is affected by each joystick function.

JOYSTICK	PORT 1		PORT 2	
	IC	PIN	IC	PIN
UP	U23	2	U23	6
DOWN	U23	3	U23	7
LEFT	U23	4	U23	8
RIGHT	U23	5	U23	9
BUTTON	U17	8	U17	9

The logic reading should go from High to Low when each function of the joystick is used. If the logic readings are correct, check IC U17 if the button is not working, and check IC U23 if the position functions are not working. If the logic reading is not correct check the components connected to the pin with the incorrect reading and check Connectors J5 or J6 for good connections.

LOGIC CHART (Continued)

PIN NO.	IC U15	IC U16	IC U17	PIN NO.	IC U17	PIN NO.	IC U18	IC U19	IC U20	IC U22	PIN NO.	IC U22
1	*	*	P	21	P	1	P	L	H	L	21	P
2	P	P	P	22	P	2	H	L	P	P	22	P
3	P	P	L	23	P	3	P	H	P	P	23	P
4	P	P	P	24	P	4	P	H	P	P	24	H
5	P	P	P	25	P	5	P	H	P	P	25	H(3)
6	P	P	P	26	P	6	P	L	L	P	26	H
7	P	P	P	27	H	7	L	*	L	P	27	H
8	H	H	H	28	P	8	H	H	L	L	28	H
9	P	P	H	29	P	9	*		L	L	29	H
10	P	P	H	30	P	10	*		L	L	30	P
11	P	P	L	31	L	11	H		P	L	31	H
12	P	P	H	32	P	12	H		P	L	32	P
13	P	P	H	33	P	13	H		*	L	33	P
14	P	P	H	34	P	14	H		P	L	34	P
15	P	P	L	35	P	15			P	L	35	P
16	L	L	P	36	P	16			H	H(1)	36	P
17			H	37	P	17				H	37	H
18			P	38	P	18				P	38	P
19			P	39	P	19				P	39	P
20			P	40	P	20				P	40	P

PIN NO.	IC U23	PIN NO.	IC U23	PIN NO.	IC U24	IC U25	IC U26	IC U27	IC U28	IC U29	IC U30	IC U31	IC U32	IC U33	IC U34
1	L	21	P	1	H(2)	P	*	*	*	*	*	*	*	*	P
2	H	22	H	2	H(2)	P	P	P	P	P	P	P	P	P	P
3	H	23	P	3	H(3)	L	P	P	P	P	P	P	P	P	H
4	H	24	H	4	H(2)	P	P	P	P	P	P	P	P	P	H
5	H	25	P	5	H(2)	P	P	P	P	P	P	P	P	P	H
6	H	26	P	6	L	L	P	P	P	P	P	P	P	P	P
7	H	27	P	7	L	L	P	P	P	P	P	P	P	P	L
8	H	28	P	8	L	L	H	H	H	H	H	H	H	H	L
9	H	29	P	9	P	P	P	P	P	P	P	P	P	P	P
10	H	30	P	10	P	P	P	P	P	P	P	P	P	P	H
11	L	31	P	11	P	P	P	P	P	P	P	P	P	P	P
12	H	32	P	12	P	P	P	P	P	P	P	P	P	P	P
13	H	33	P	13	H(2)	P	P	P	P	P	P	P	P	P	P
14	H	34	H	14	H(2)	P	P	P	P	P	P	P	P	P	H
15	H	35	P	15	H(2)	P	H	H	H	H	H	H	H	H	P
16	H	36	P	16	H	H	L	L	L	L	L	L	L	L	H
17	H	37	H	17											
18	H	38	H	18											
19	H	39	H	19											
20	H	40	H	20											

ATARI
 MODEL 130XE

LOGIC CHART

PIN NO.	IC U1	IC U2	IC U3	IC U4	PIN NO.	IC U4	PIN NO.	IC U5	PIN NO.	IC U5	PIN NO.	IC U6	PIN NO.	IC U6
1	*	P	P	P	21	P	1	H	21	P	1	P	21	P
2	*	P	P	P	22	P	2	P	22	P	2	P	22	P
3	*	P	P	P	23	P	3	P	23	P	3	H	23	P
4	L	P	P	P	24	H	4	P	24	P	4	P	24	P
5	*	L	P	P			5	P	25	P	5	P	25	P
6	*	H	H	P			6	P	26	P	6	L	26	P
7	*	P	L	P			7	P	27	H	7	L	27	P
8	H	L	L	P			8	P	28	H	8	P	28	P
9		H	H	P			9	P			9	P	29	P
10		P	L	P			10	P			10	P	30	P
11		P	P	P			11	P			11	P	31	P
12		P	H	L			12	P			12	P	32	P
13		P	H	P			13	P			13	P	33	P
14		P	H	P			14	L			14	P	34	P
15		P	P	P			15	P			15	P	35	P
16		H	P	P			16	P			16	P	36	P
17			P	P			17	P			17	P	37	P
18			L	P			18	P			18	P	38	P
19			H	P			19	P			19	P	39	H
20			H	H			20	P			20	L	40	H

PIN NO.	IC U7	PIN NO.	IC U7	PIN NO.	IC U8	PIN NO.	IC U8	PIN NO.	IC U9	IC U10	IC U11	IC U12	IC U13	IC U14
1	L	21	H	1	L	21	L	1	*	*	*	*	*	*
2	P	22	P	2	H	22	P	2	P	P	P	P	P	P
3	P	23	P	3	P	23	P	3	P	P	P	P	P	P
4	L	24	P	4	H	24	P	4	P	P	P	P	P	P
5	P	25	P	5	*	25	P	5	P	P	P	P	P	P
6	H	26	P	6	P	26	P	6	P	P	P	P	P	P
7	P	27	P	7	P	27	P	7	P	P	P	P	P	P
8	P	28	P	8	H	28	P	8	H	H	H	H	H	H
9	P	29	P	9	P	29	P	9	P	P	P	P	P	P
10	P	30	P	10	P	30	P	10	P	P	P	P	P	P
11	P	31	P	11	P	31	P	11	P	P	P	P	P	P
12	P	32	P	12	P	32	P	12	P	P	P	P	P	P
13	P	33	P	13	P	33	P	13	P	P	P	P	P	P
14	P	34	P	14	P	34	*	14	P	P	P	P	P	P
15	H	35	P	15	P	35	P	15	P	P	P	P	P	P
16	P	36	H	16	P	36	P	16	L	L	L	L	L	L
17	P	37	P	17	P	37	P	17						
18	P	38	P	18	P	38	L	18						
19	P	39	P	19	P	39	P	19						
20	P	40	P	20	P	40	H	20						

PARTS LIST AND DESCRIPTION

When ordering parts, state Model, Part Number, and Description

SEMICONDUCTORS (Select replacement for best results)

ITEM No.	TYPE No.	MFR. PART No.	REPLACEMENT DATA				NOTES
			NTE PART No.	ECG PART No.	RCA PART No.	ZENITH PART No.	
CR2 thru CR5	1N4148F		NTE519	ECG519	SK3100/519	103-131	(1) (2)
Q1 thru Q3 Q4, 5	2N3904		NTE123AP NTE123AP	ECG123AP ECG123AP	SK3854/123AP SK3854/123AP	121-Z9000A 121-Z9000A	
Q6	MPSA55		NTE123AP	ECG123AP	SK3854/123AP	121-Z9000A	
Q7	LM358N		NTE159	ECG159	SK3466/159	121-Z9003	
U1	M74LS138P		NTE928M	ECG928M	SK3692/928M	HE-443-877	
U2	C061618-16		NTE74LS138	ECG74LS138	SK74LS138		
U3							
U4	NCR2364-30						
	M449192						
	C024947A						
U5	NCR23128-30						
	M450072						
	C061598B						
U6	NCRF815103G						
	C061991-29						
U7	C021697-11						
U8	NCRF811521A						
	C014806C-29						
U9 thru U15	MT4264-15		NTE4164	ECG2164		HE-443-970	
U16	D4164C-15		NTE4164	ECG2164		HE-443-970	
U17	I10008-01						
	C014805-31						
U18	M74LS08P		NTE74LS08	ECG74LS08	SK74LS08	HE-443-780	
U19	UA555TC		NTE955M	ECG955M	SK3564/955M	221-Z9042	
U20	HD14050BP		NTE4050B	ECG4050B	SK4050B	221-Z9163	
U21			NTE74LS74A	ECG74LS74A	SK74LS74A	HE-443-730	
U22	C03051						
	C012294B-01						

CC16

ATARI
MODEL 130XE

When ordering parts, state Model, Part Number, and Description

SEMICONDUCTORS (Select replacement for best results)

ITEM No.	TYPE No.	MFGR. PART No.	REPLACEMENT DATA				NOTES
			NTE PART No.	ECG PART No.	RCA PART No.	ZENITH PART No.	
U23	R6520-26		NTE4051B	ECG4051B	SK4051B	905-380	(1) (3)
U24,5	C014795-12						
U26 thru U33	HD14051BP SAME AS U9						
U34	C025953 (PAL IC)						
U35							

(1) Used in some versions.

(2) Used in European models.
(3) Used with U34 PLA IC.

PARTS LIST AND DESCRIPTION

When ordering parts, state Model, Part Number, and Description

ELECTROLYTIC CAPACITORS

ITEM No.	RATING	MFGR. PART No.
C19	4.7 35V Non Polarized	
C20	4.7 35V Non Polarized	

ITEM No.	RATING	MFGR. PART No.
C22	4.7 35V Non Polarized	

COILS & TRANSFORMERS

ITEM No.	FUNCTION	MFGR. PART No.	OTHER IDENTIFICATION	NOTES
L6	Peaking (100uH)			
L8	Peaking			
L13	Peaking (1.5uH)			
L14	Peaking (22uH)			
L15	Peaking (10uH)			
thru L23				
L25	Peaking (10uH)			
thru L30				
L32	Peaking (100uH)			

CONTROLS (All wattages 1/2 watt, or less, unless listed)

ITEM NO.	FUNCTION	RESISTANCE	MFGR. PART NO.	NOTES
R38	Color	500K		

ATARI
MODEL 130XE

MISCELLANEOUS

ITEM No.	PART NAME	MFGR. PART No.	NOTES
L1 thru L3	Ferrite Bead		
L5	Ferrite Bead		
L7	Ferrite Bead		
L9	Ferrite Bead		
thru L12			
L31	Ferrite Bead		
L37	Ferrite Bead		
L102	Ferrite Bead		
S1	Switch		
Y1	Crystal		Power 14.31818MHz
Y2	Crystal		4.433618MHz
Feet			RUSSELL Industries Replacement PAD-5012 (4 required)

WIRING DATA

Shielded Hook-up Wire	Use BELDEN No. 8401 or 8421 (Single-Conductor) 8208 (Two-Conductor)
General-use Unshielded Hook-up Wire	Use BELDEN No. 8529 (Solid) Available in 13 Colors 8522 (Stranded) Available in 13 Colors
300-Ohm Input Lead	Use BELDEN No. 8225
75-Ohm Input Lead	Use BELDEN No. 8241

PRELIMINARY SERVICE CHECKS (Continued) PREVENTATIVE MAINTENANCE

ENVIRONMENT

Computers perform best in a clean, cool area that is below 80 degrees Fahrenheit and free of dust and smoke particles. Even though home Computers are not affected by cigarette smoke as much as commercial Computers are affected, it is better to maintain a smoke-free area around the Computer. Do not block cabinet vents of any of the Computer system; Computer, Monitor, Printer, or other power devices.

ELECTRICAL POWER

Variations in the line voltage can affect the Computer. Try to avoid these fluctuations by using an AC receptacle that is on a power line not used by appliances or other heavy current demand devices. A power-surge protector, power-line conditioner, or non-interruptable power supply may be needed to cure the problem. **Do not** switch power On and Off frequently.

KEYBOARD

Liquids spilled into the Keyboard can ruin it. Immediately after a spill occurs, disconnect the Computer power plug from AC power outlet. Then, if circuitry or contacts are contaminated, disassemble the Keyboard and carefully rinse the Keyboard printed circuit board with distilled water and let it dry. Use a cotton swab to clean between the keys. Use a non-abrasive contact cleaner and lint-free wipers on accessible connectors and contacts.

DISK DRIVES

Clean the read/write heads of the Disk Drives about once a month or after 100 hours usage. Use only an approved head cleaning kit.

Handle carefully to preserve proper disk head alignment. A sudden bump or jolt to the Disk Drives can knock the disk head out of alignment. If the disk drive must be transported, place an old disk in slot and close door during transport.

Store disks in their protective covers and never touch the disk surface. Observe the disk handling precautions usually found on the back of disk protective covers.

PRINTERS

Carefully vacuum the Printer regularly. Wipe surface areas clean using a light all-purpose cleaner. Do not oil the machine. The oil will collect abrasive grit and dust. The dust will act as a blanket. This can cause components to overheat and fail.

STATIC ELECTRICITY

Static electricity discharge can affect the Computer. In order to minimize the possibility, use anti-static mats, sprays, tools and materials, and maintain good humidity in the Computer environment.

MONITOR

Use an isolation transformer with any Monitor that does not come as part of the system since some Monitors use a HOT chassis (chassis connected to one side of the AC line). The face of the Monitor should never be left on for long periods of time at high brightness level except when pattern is being changed periodically. Use caution when cleaning anti-glare screens, to preserve the glare-reduction feature.

PRELIMINARY SERVICE CHECKS

This data provides the user with a time-saving service tool which is designed for quick isolation and repair of Computer malfunctions.

Check all interconnecting cables for good connection and correct hookup before making service checks.

Disconnect all peripherals except the Monitor from the Computer to eliminate possible external malfunctions.

Replacement or repair of the power supply, main board, keyboard, or connectors may be necessary after the malfunction has been isolated.

TEST EQUIPMENT AND TOOLS

TEST EQUIPMENT

Digital Volt/Ohm Meter

TOOLS

Low Wattage Soldering Iron
Desoldering Equipment
Switch Cleaner (non spray type)
Phillips Screwdriver
Flat Blade Screwdriver
IC Insertion and Removal Tools 16, and 40 pin
Alignment Tools GC Electronics 9440

REPLACEMENT PARTS AND DESCRIPTION

IDENT	DESCRIPTION
S1	Switch, Power
U7	IC, ANTIC
U8	IC, CPU
U9	IC, RAM
thru	
U16	
U17	IC, GTIA
U22	IC, Pokey

ATARI
MODEL 130XE
CC16

ATARI
MODEL 130XE
CC16

SAMS™ Howard W. Sams & Co.
4300 West 62nd Street, P.O. Box 7092, Indianapolis, Indiana 46206 U.S.A.

The listing of any available replacement part herein does not constitute in any case a recommendation, warranty or guaranty by Howard W. Sams & Co. as to the quality and suitability of such replacement part. The numbers of these parts have been compiled from information furnished to Howard W. Sams & Co. by the manufacturers of the particular type of replacement part listed.

Reproduction or use, without express permission, of editorial or pictorial content, in any manner, is prohibited. No patent liability is assumed with respect to the use of the information contained herein.

© 1986 Howard W. Sams & Co.
4300 West 62nd Street, P.O. Box 7092, Indianapolis, Indiana 46206 U.S.A.
Printed in U.S. of America. 86CC14978 DATE 8-86

PRELIMINARY SERVICE CHECKS (Continued)

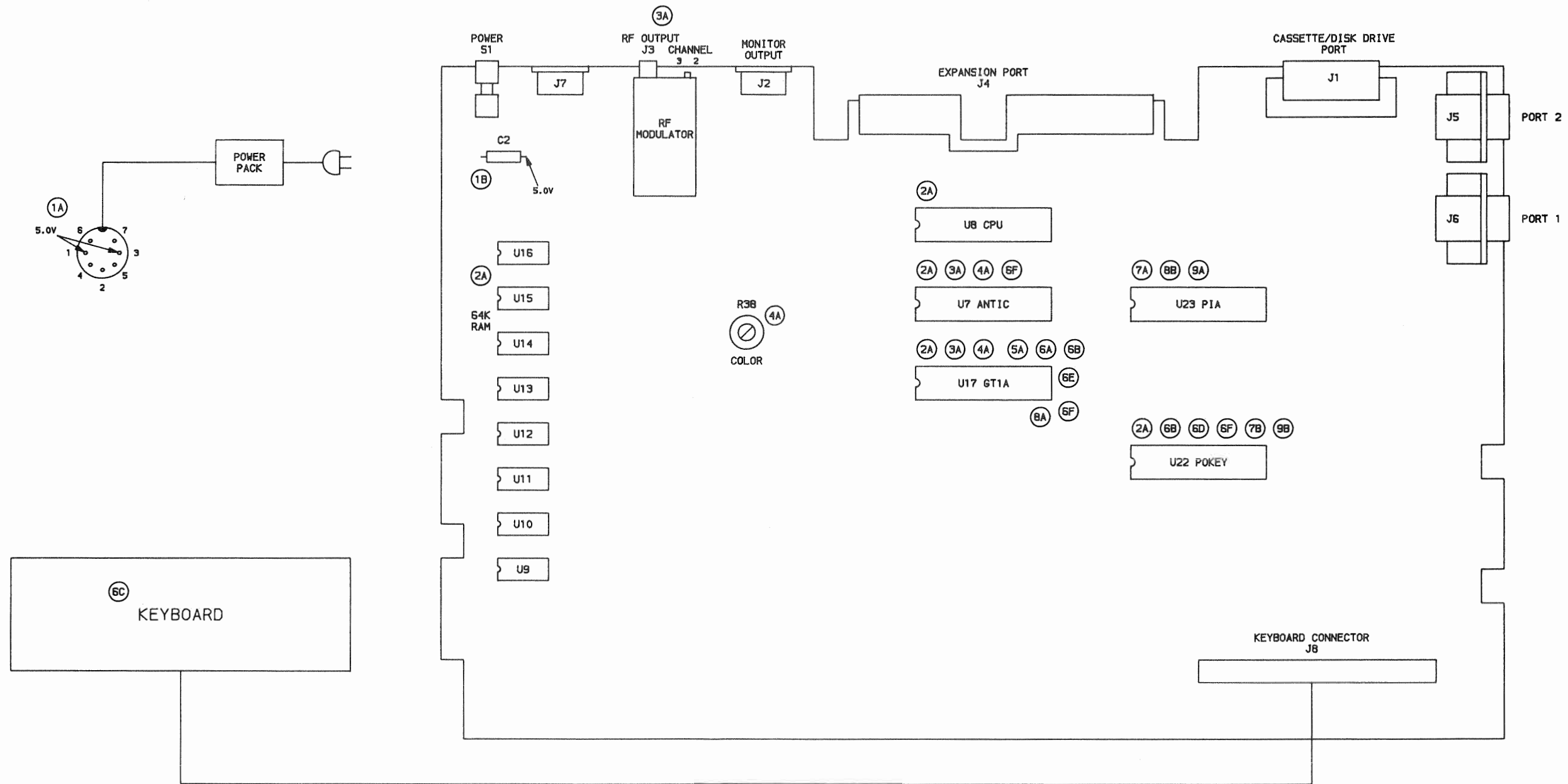

ATARI
MODEL 130XE

PRELIMINARY SERVICE CHECKS (Continued)

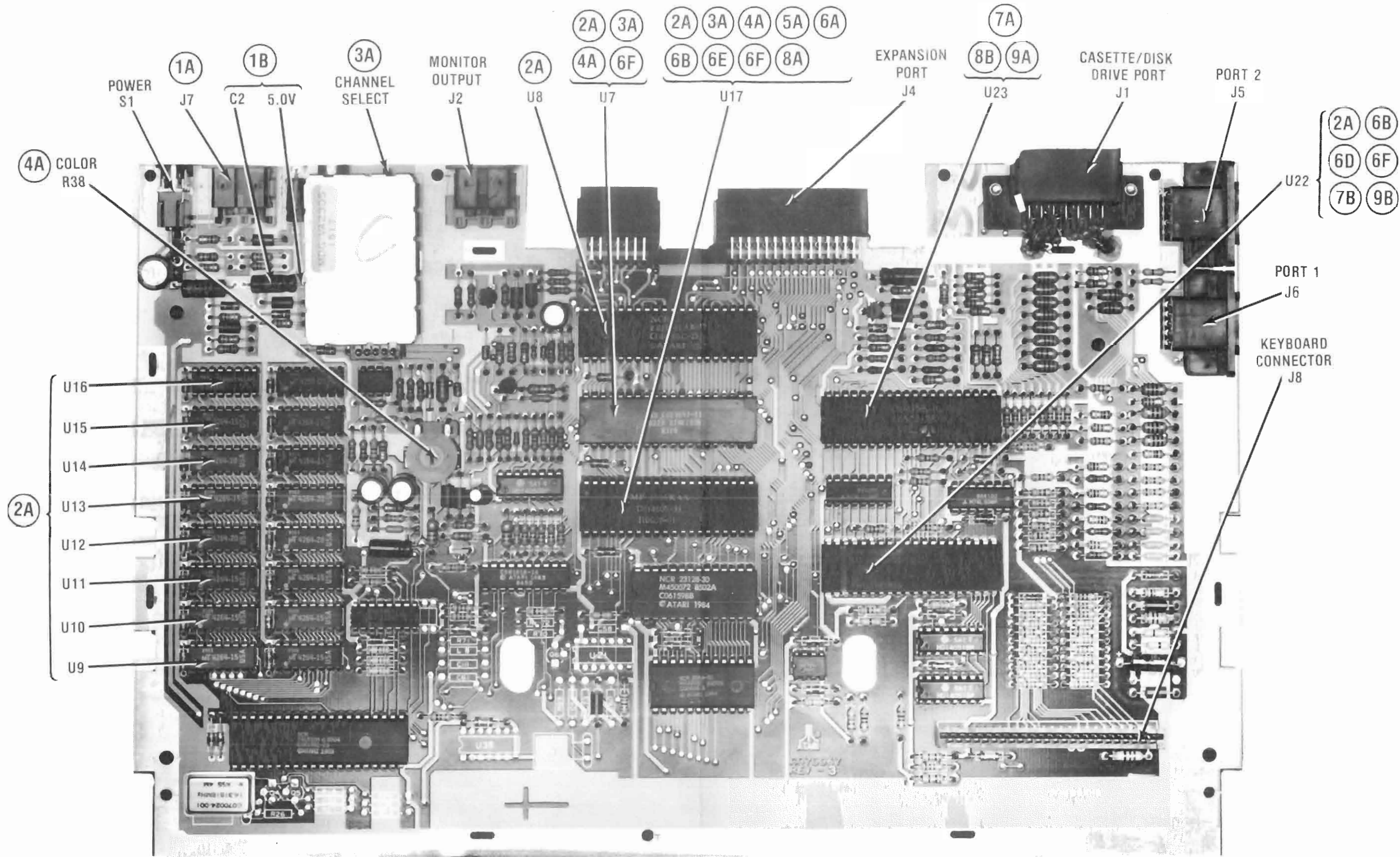

CC16
ATARI
MODEL 130XE

PRELIMINARY SERVICE CHECKS (Continued)

SERVICE CHECKS

MATCH THE NUMBERS ON THE INTERCONNECTING DIAGRAM AND PHOTOS WITH THE NUMBERS ON THE SERVICE CHECKS TO BE PERFORMED.

- ① **COMPUTER DEAD**
- (A) Unplug the Power Pack and check for 5.0V from pin 3 to pin 1 of Plug P7. If 5.0V is missing, check Plug P7 and the cable for possible open circuits. If the Power Pack is bad, check for a possible short from pin 3 to pin 1 of Jack J7 with the Power Switch (S1) in the On position. If a short exists Do Not plug in a new power pack until the short is repaired.
- (B) If the Power Pack is good, turn the Computer On and check for 5.0V on the positive end of Electrolytic C2. If 5.0V is missing, check the Power Switch (S1).
- ② **COMPUTER DOES NOT COME UP PROPERLY**
- (A) Check the CPU IC (U8), GTIA IC (U17), POKEY IC (U22), ANTIC IC (U7) and RAM IC's U9 thru U16.
- ③ **VIDEO**
- (A) No video. If RF Modulator output is being used check the Channel Switch (S2) for correct channel. Check the ANTIC IC (U7) and GTIA IC (U17).
- ④ **COLOR**
- (A) Color not correct or no color. Check the adjustment of the Color Control (R38). See "Miscellaneous Adjustments" and check the ANTIC IC (U7) and GTIA IC (U17).
- ⑤ **SYNC**
- (A) No vertical or horizontal sync. Check GTIA IC (U17).
- ⑥ **KEYBOARD**
- (A) No clicking sound when a key is pressed. Check GTIA IC (U17).
- (B) Keyboard is dead. Check IC U17 and POKEY IC (U22).
- (C) One key is erratic. Clean the key.
- (D) One group of keys does not work. Check IC U22.
- (E) START, SELECT or OPTION Function keys or SHIFT, CONTROL and BREAK keys do not work. Check IC U17.
- (F) Wrong characters appear on the Monitor Screen when key is pressed. Check the ANTIC IC (U7), and IC's U17 and U22.
- ⑦ **CASSETTE**
- (A) Cassette motor will not start. Check PIA IC (U23).
- (B) Cassette save or load does not work. Check POKEY IC (U22).
- ⑧ **JOYSTICKS**
- (A) Joystick button does not work. Check GTIA IC (U17).
- (B) Joystick position functions do not work. Check PIA IC (U23).
- ⑨ **PADDLES**
- (A) Paddle button does not work. Check PIA IC (U23).
- (B) Paddle control does not work. Check POKEY IC (U22).

PRELIMINARY SERVICE CHECKS (Continued)

DISASSEMBLY INSTRUCTIONS

CABINET REMOVAL

Remove four screws from cabinet bottom. Lift cabinet top up and disconnect keyboard cable. Cabinet top may now be removed.

MAIN BOARD REMOVAL

Remove seven screws holding PC board to cabinet bottom. Lift PC board and metal shield from cabinet bottom. To remove shield, twist seven tabs holding shield together and remove shield from main board.

MISCELLANEOUS ADJUSTMENTS

COLOR

Turn the Computer On and adjust the Color Control (R38) for a blue screen on the Monitor.

GENERAL OPERATING INSTRUCTIONS

POWER UP

Computer will come up ready to program in Basic when turned On.

For instructions on loading and saving programs with an Atari Recorder see the "Cassette Operation" section.

To run a program type RUN and press the RETURN key. To stop a program, press the BREAK key.

CASSETTE OPERATION

Connect the Atari Program Recorder to the connector on the right side of the Computer. NOTE: A standard tape recorder will not work with this Computer.

To load a program, type CLOAD and press the RETURN key. The speaker will beep once. After the speaker beeps, push the PLAY button on the Recorder and press the RETURN key again. The program will then load. The word READY on the screen indicates the loading is completed. The Recorder will shut-off automatically.

To save a program, type CSAVE and press the RETURN key. The speaker will beep twice. After the speaker beeps, press the PLAY and RECORD buttons on the Recorder and then press the RETURN key. The program will then save. The word READY on the screen indicates the program has been saved. The Recorder will shut-off automatically.

ATARI
MODEL 130XE

Remove staples and use cover for file folder.

COMPUTERFACTS™ put easy to use, informative technical data right at your fingertips. Each edition includes specific service information on the individual component, along with some overall troubleshooting hints.

- The following information is just a sample of the many valuable time saving features contained in this exclusive Sams COMPUTERFACTS publication:
- Preliminary Service Checks section is an easy to use, step by step guide for the experienced technician or hobbyist, and even beginners.
- SAMS famous industry accepted standardized notation schematics containing CIRCUITRACE®, GRIDTRACE™, waveforms, voltages and stage identification.

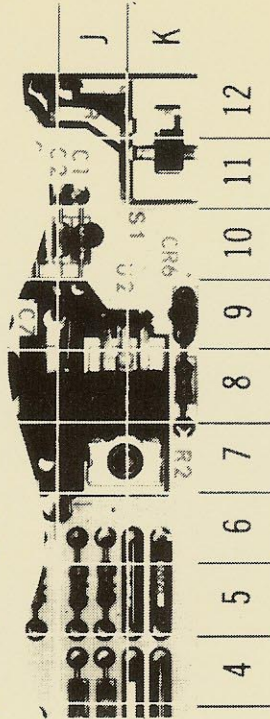
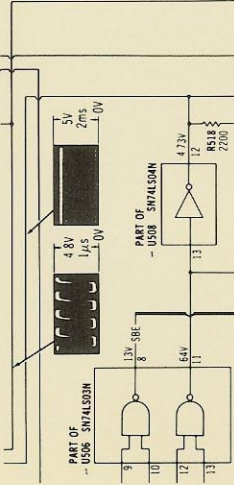

- Complete Components Parts List in an easy to use format with field replacements shown when possible. SAMS unique semiconductor, chip and IC cross-reference gives you many replacements to choose from and is available at your Electronic Distributor.

SEMICONDUCTORS (Select replacement for best results)

ITEM No.	TYPE No.	MEGR. PART No.	EGG PART No.	GENERAL ELECTRIC PART No.	REPLACEMENT DATA				ZENITH PART No.
					MOTOROLA PART No.	NIE PART No.	RCA PART No.	WORKMAN PART No.	
D102	1S553	1149-2576	EC0519	GE-514	1M4935	NTE519	SK9091/177	MEP25/519	103-131
D103	1N60FM	1149-2527	ECG109	1N60	1M4004	NTE109	SK3088	MEP134/109	103-29001
D201	1N4004GP	1201-4205	ECG116	GE-504A	1N4004	NTE116	SK3312	MEP57/519	103-14002
D501	1S553	1149-2576	EC0519	GE-514	1M4935	NTE519	SK9091/177	MEP25/519	103-131

CIRCUITRACE is a registered trademark of Howard W. Sams & Co., Inc. COMPUTERFACTS and GRIDTRACE are trademarks of Howard W. Sams & Co., Inc. ATARI is a registered trademark of Atari, Inc., a Warner Communications Company.

To order, or for more information see your Sams Distributor, or telephone 800-428-SAMS.

SAMS™ Howard W. Sams & Co.
A Division of Macmillan, Inc.

4300 West 62nd Street, Indianapolis, Indiana 46268

CC16
08978

ISBN: 0-672-08978-5

- Step by Step Troubleshooting guides the technician through the necessary procedures to quickly locate the problem.

TROUBLESHOOTING

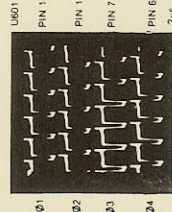

MICROPROCESSOR CHIP (CPU) OPERATION

Verify the processor is functioning by checking the signals on the address lines (pins 10 thru 24 of IC U600) and the data lines (pins 41 thru 56) using a logic probe or a scope. If a logic probe is used, refer to the "Logic Chart" for the correct logic levels. Note that pins 22 and 23 which have no signal in PowerUp mode should be similar to Figure 1. The waveforms on the data lines should be similar to Figure 2.

- Logic Chart containing logic probe readings to isolate defective circuitry and components.

PIN NO.	IC U100	PIN NO.	IC U100	IC U102	IC U103	IC U104	IC U105	IC U106	IC U107	IC U108	IC U109
1	P	21	P	1	L	L	L	L	L	L	L
2	P	22	P	2	P	P	P	P	P	P	P
3	P	23	P	3	H	H	H	H	H	H	H